



A SilverLeaf Design LLC Company

# KROY

## Sign Systems

## OVERHEAD SIGNS

Clearly identify specific departments with visually dominant Overhead Signs. Complement existing room signs and floor directories within your facility. Achieve ADA (American with Disabilities Act) compliance with contrasting colors, type styles and graphics. Overhead Signs are flexible, functional and effective in any public and private facility.

With individual panels weighing less than 7 pounds, Overhead Signs are easy to install. Signs are easily affixed to any standard drop-ceiling, as well as other ceiling finishes. Flush mounted and suspended sign installations are quick and easy. Overhead placement provides visibility and communication for effective pedestrian traffic flow.

Fabricated from expanded PVC, sign panels are durable and dimensional. Overhead panels and cubes are available in a variety of stock and custom sizes, finished or unfinished.

Available in your choice of radius or square corners, overhead panels and cubes can be finished to match any existing environmental or sign system specification. Finished overheads include eye-catching, vivid colors and easy to read graphics. Single-sided, double-sided or changeable message applications are also available. For changeability, simply specify an optional clear acrylic lens with changeable message inserts.

Overhead Signs are proven communicators that positively impact pedestrian traffic flow. Impact one's sense of direction with Overhead Directionals.

For more information on this or other Kroy Sign products, call 1-800-950-5769, send us an email or visit us on the web.

signs@kroysignsystems.com • www.kroysignsystems.com

*Quality*



*Service*

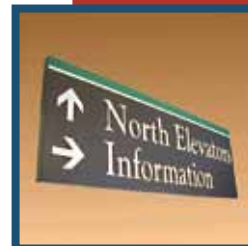

*Innovation*

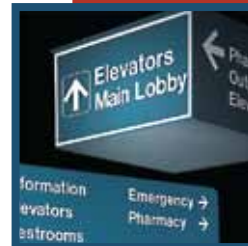

*Esthetics*

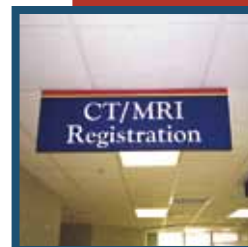

## OVERHEAD SIGNS

### Specification Data

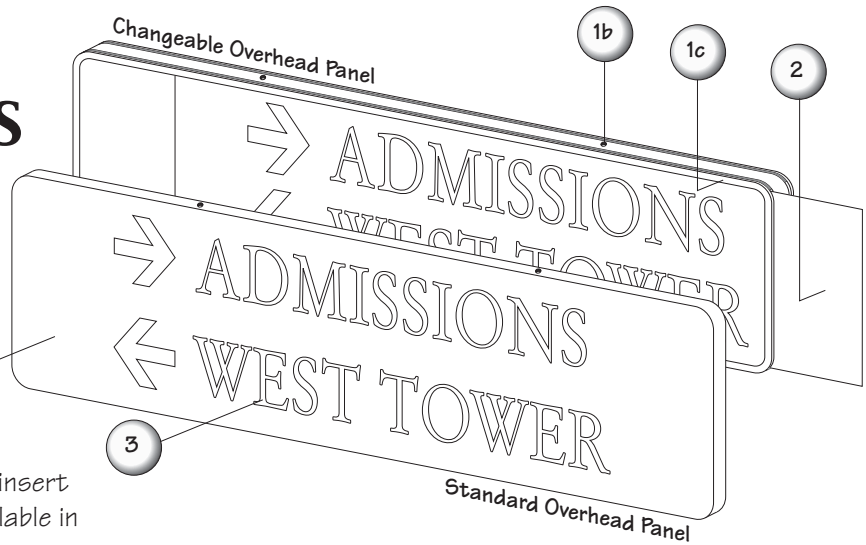

#### 1 Panel

(1a) 1-1/4" deep fabricated expanded PVC overhead  
 (1b) 1/4"-20 threaded mounting holes.

(1c) Optional 1/16" non-glare clear acrylic lens with 3/8" borders and insert slot(s) for changeability. Panels are available in square or radius corner. (1d) Cube features mounting lip for suspending through standard 24" ceiling panel grid opening.

#### 2 Insert (optional)

.020" thick polystyrene insert.

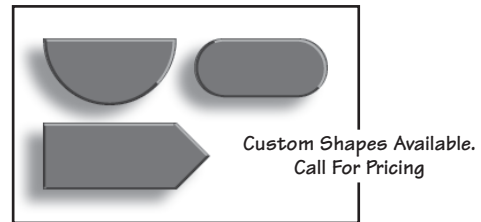

#### 3 Graphics

Vinyl text and graphics are surface applied to panel face or applied to changeable polystyrene inserts.

#### 4 Colors

White (unfinished) or surface painted with Matthews acrylic polyurethane to match Kroy standard colors or customer specified color.

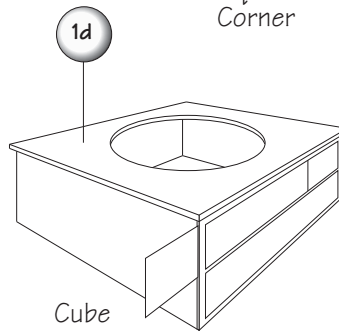
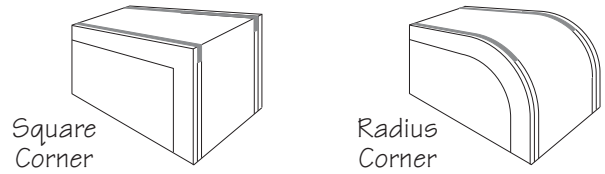

- Overheads available in radius or square corner.
- Custom shapes and sizes are also available. Call for specifications and pricing.
- Optional lens and changeable styrene insert(s) provide quick, simple and inexpensive sign updates.
- Intersection cubes fit into existing suspended ceiling grids.
- Standard overheads weigh less than 7 pounds each.

### Standard Kroy Sizes and Styles

Standard	Changeable, 1-slot	Changeable, 2-slot	Changeable, 3-slot
10.5" x 24"			
10.5" x 38.5"			
15.5" x 38.5"			
10.5" x 57.5"			
15.5" x 57.5"			

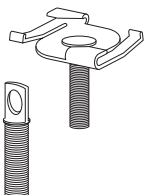

#### Mounting Options

- Ceiling Grid Clip
- Threaded Studs
- Airline Cable
- Mounting Plate

#### Summary: 2010 ADA Standards for Accessible Design

Signs must conform to rule 1 for identification signs concerning non-glare finish and contrast. Signs cannot be constructed of shiny metals, highly polished woods, or shiny plastics. They cannot utilize high gloss paints or vinyls. Both upper and lower case characters can be used. Signs which are suspended from ceiling or projected above 80 inches from the finish floor must have characters at least three (3) inches in height.